



About US

✓Youth Green Lighting has been committed to providing energy-efficient lighting products to the commercial building, residential and OEM markets since 2005.

✓Our LED products are LM-79 and LM-80 tested . ETL and Energy Star listed, and backed by industry-leading warranties.

✓We work with our customers to ensure that our products meet the needs of their installation by providing a full range of complimentary services

✓Youth Green Lighting keep our products in stock and available for immediate purchase and delivery, shipping within the United States in one two business days on standard orders.

R & D

✓Youth Green Lighting is one of the most professional LED provider of specialty services to North America's process industries. We pay attention to the unique technical and safety challenges that this type of work involves.

✓Our company was founded in 2005 as a local enterprise manufacturing various LED products and providing services to our customers. Focusing on long-term and sustainable development concepts, today we are positioned to be a resource optimization expert in Lighting industry.

Quality

✓Established as a local business in 2010, Youth Green Lighting has changed about us over the last 10 years of company history but our commitment to quality standards and customer service is stronger than ever.

✓Our quality standards meet the highest benchmarks in the world, but we believe there are always opportunities to improve. An extensive quality management system and dedicated inspection department with roaming shop floor inspectors ensure parts are manufactured to meet design and fabrication specifications and that production standards are maintained to a high level.



Damp Locations LED SLIM PANEL LIGHTS

Products:



Applications

Ideal for Basements, Bars, Hotels, Shops, Restaurants, Accent Lighting, Clubs, Bakeries, Showcases, Hutches and can also be used as a Night Light or Staircases.

Features

- ETL / cETL / Energy star approved
- 120V Triac Dimmable
- Available in Multiple Colors
- IC Rated
- Damp Location
- 25 Degree Adjustable
- 5 Years Warranty
- UL waterproof cable
- Strong spring clips
- Square shape is also available
- Wall switch 3 color changeable is available

| Item | LP3RD5W3K-WH | LP4RD9W3K-WH | LP6RD12W3K-WH | LP8RD18W3K-WH | LP12RD24W3K-WH |
|---|-----------------------------|----------------------------------|----------------------------------|-----------------------------|-----------------------------|
| Color Temp (CCT) | 3000K/4000K/ 5000K/6000K | 3000K/4000K/ 5000K/6000K/3CCT | 3000K/4000K/ 5000K/6000K/3CCT | 3000K/4000K/ 5000K/6000K | 3000K/4000K/ 5000K/6000K |
| Color Rendering Index (CRI) | ≥80Ra | ≥80Ra | ≥80Ra | ≥80Ra | ≥80Ra |
| Input Voltage | 120V | 120V | 120V | 120V | 120V |
| Lumen Output | 450LM | 750LM | 1000LM | 1260LM | 2040LM |
| Total Power | 5W | 9W | 12W | 18W | 24W |
| Lumen | 85lm/W | 85lm/W | 85lm/W | 85lm/W | 85lm/W |
| Beam Angle | 180° | 180° | 180° | 180° | 180° |
| Life Span | 50000hrs | 50000hrs | 50000hrs | 50000hrs | 50000hrs |
| Operating Temperature | -20°C ~ +55°C | -20°C ~ +55°C | -20°C ~ +55°C | -20°C ~ +55°C | -20°C ~ +55°C |
| Storage Temperature | -30°C ~ +65°C | -30°C ~ +65°C | -30°C ~ +65°C | -30°C ~ +65°C | -30°C ~ +65°C |
| Application | Indoor | Indoor | Indoor | Indoor | Indoor |
| IP Rating | IP43 | IP43 | IP43 | IP43 | IP43 |
| Dimmable | Yes | Yes | Yes | Yes | Yes |
| Cut-out | 3 Inch | 4 Inch | 6 Inch | 8 Inch | 12 Inch |
| Housing Color | White | White | White | White | White |
| Estimated Energy Cost (based on 5 hrs/day) | \$1.095/year | \$2.19/year | \$3.285/year | \$3.65/year | \$4.38/year |
| Years it lasts (based on 5 hrs/day) | 25 | 25 | 25 | 25 | 25 |

Wet Locations LED SLIM PANEL LIGHTS

Products:



Applications

Ideal for Basements, Bars, Hotels, Shops, Restaurants, Accent Lighting, Clubs, Bakeries, Showcases, Hutches and can also be used as a Night Light or Staircases.

Features

- ETL / cETL / Energy star approved
- 120V Triac Dimmable
- Available in Multiple Colors
- IC Rated
- Wet Location
- 25 Degree Adjustable
- 5 Years Warranty
- UL waterproof cable
- Strong spring clips
- Square shape is also available
- Wall switch 3 color changeable is available

| Specs | LP4RD9W3K-WH/WL | LP6RD12W3K-WH/WL |
|--|----------------------------------|----------------------------------|
| Color Temp (CCT) | 3000K/4000K/ 5000K/6000K/3CCT | 3000K/4000K/ 5000K/6000K/3CCT |
| Color Rendering Index (CRI) | ≥80Ra | ≥80Ra |
| Input Voltage | 120V | 120V |
| Lumen Output | 750LM | 1000LM |
| Total Power Lumen | 9W 85lm/W | 12W 85lm/W |
| Beam Angle | 180° | 180° |
| Life Span | 50000hrs | 50000hrs |
| Operating Temperature | -20°C ~ +55°C | -20°C ~ +55°C |
| Storage Temperature | -30°C ~ +65°C | -30°C ~ +65°C |
| Application | Indoor | Indoor |
| IP Rating | IP54 Wet Location | IP54 Wet Location |
| Dimmable | Yes | Yes |
| Cut-out | 4 Inch | 6 Inch |
| Housing Color | White | White |
| Estimated Energy Cost (based on 5 hrs/day) | \$1.642/year | \$2.19/year |
| Years it lasts (based on 5 hrs/day) | 25 | 25 |

WIFI LED SLIM PANEL LIGHTS

Products:



Applications

Ideal for Kitchens, Bathrooms, Hotels, Pools, Restaurants, Showers, Fitness Clubs, Showcases can also be used in a Night Club or on Staircases.

Features

- ETL / cETL approved
- Voice & APP control
- RGB+White(2000K-6000K) Colors
- Work with Google Assistant /Amazon Alexa
- Schedule or timer, Group multiple lights
- 5 Years Warranty
- No Distance Limited
- NO NEED switch, NO NEED dimmer, use Mobile
- Phone control directly

| Specs | LP4RD9WRGBW-WH/WF | LP6RD12WRGBW-WH/WF |
|--|-------------------|--------------------|
| Color Temp (CCT) | RGBW | RGBW |
| Color Rendering Index (CRI) | ≥80Ra | ≥80Ra |
| Input Voltage | 120V | 120V |
| Lumen Output | 750LM | 1000LM |
| Total Power | 9W | 12W |
| Lumen | 85lm/W | 85lm/W |
| Beam Angle | 180° | 180° |
| Life Span | 50000hrs | 50000hrs |
| Operating Temperature | -20°C ~ +55°C | -20°C ~ +55°C |
| Storage Temperature | -30°C ~ +65°C | -30°C ~ +65°C |
| Application | Indoor | Indoor |
| IP Rating | IP44 | IP44 |
| Dimmable | Yes | Yes |
| Cut-out | 4 Inch | 6 Inch |
| Housing Color | White | White |
| Estimated Energy Cost (based on 5 hrs/day) | \$1.642/year | \$2.19/year |
| Years it lasts (based on 5 hrs/day) | 25 | 25 |

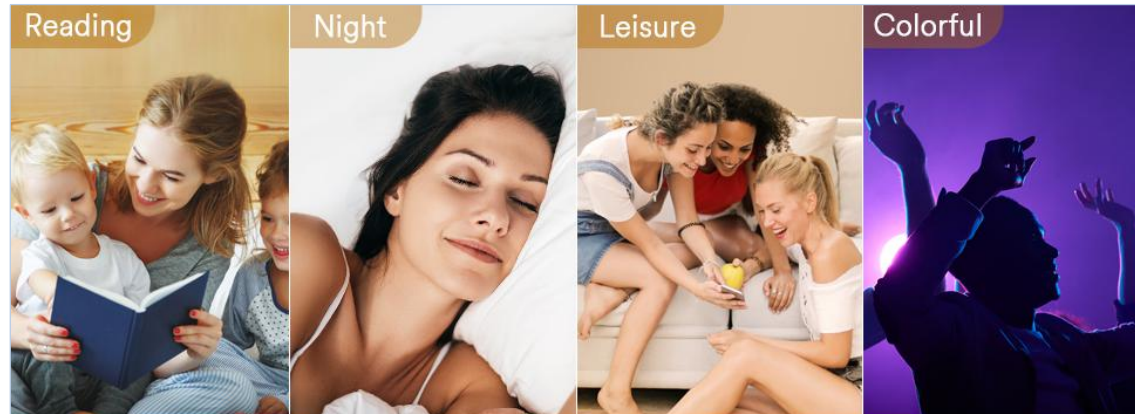
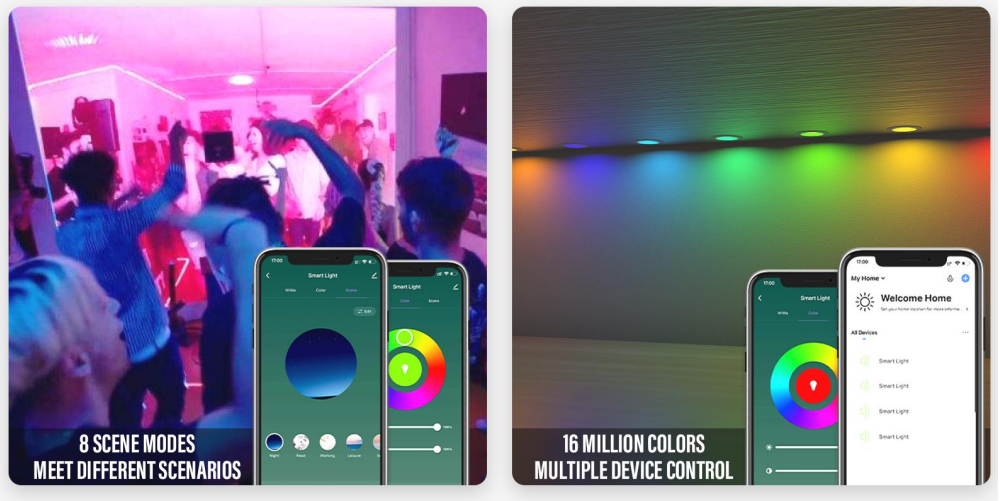

8 Scenes & Custom Scenes

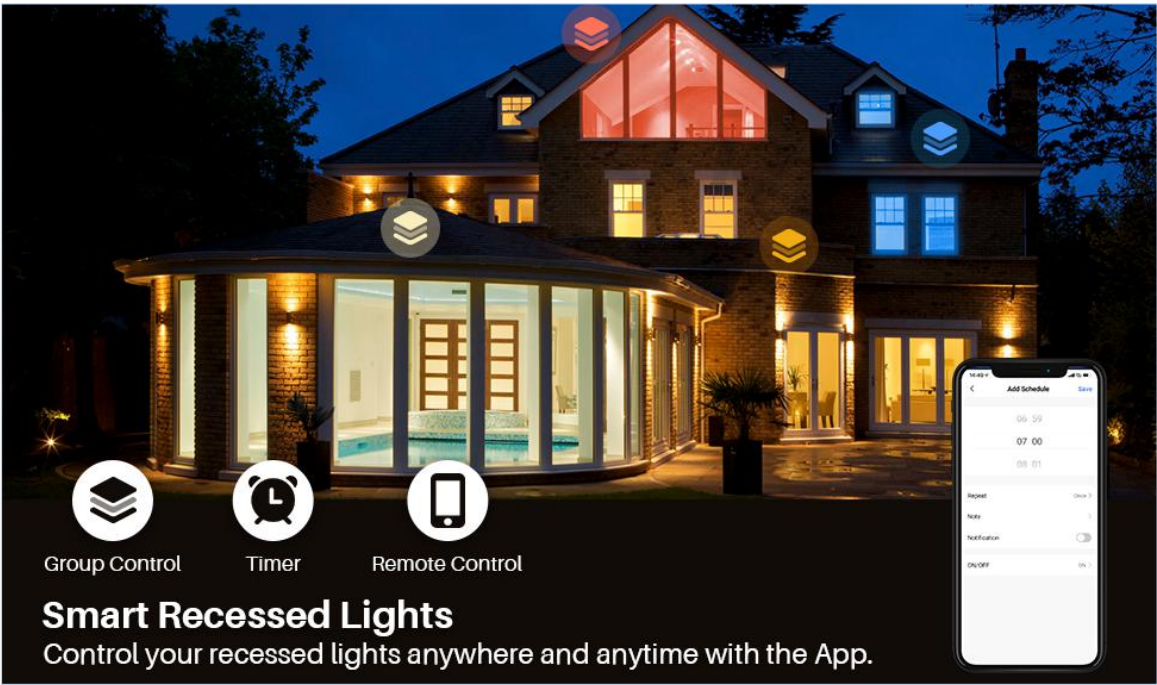

2.4G Remote Control LED SLIM PANEL LIGHTS

Products:



Applications

Ideal for Kitchens, Bathrooms, Hotels, Pools, Restaurants, Showers, Fitness Clubs, Showcases can also be used in a Night Club or on Staircases.

Features

- ETL / cETL / approved
- Wireless Light Temperature Control: 3CCT Adjustable, K+, K-
- Wireless Dimming dimmable, brightness +, brightness -,
- No Dimmer Needed
- Group Control: without limit, 1 apartment 1 remote controller
- Night Mode
- Wireless Power ON/OFF Control
- 5 Years Warranty

| Specs | LP4RD9W3CCT-WH/2.4G | LP6RD12W3CCT-WH/2.4G |
|--|-------------------------|-------------------------|
| Color Temp (CCT) | 3000K/3500K/4000K/5000K | 3000K/3500K/4000K/5000K |
| Color Rendering Index (CRI) | ≥80Ra | ≥80Ra |
| Input Voltage | 120V | 120V |
| Lumen Output | 750LM | 1000LM |
| Total Power | 9W | 12W |
| Lumen | 85lm/W | 85lm/W |
| Beam Angle | 180° | 180° |
| Life Span | 50000hrs | 50000hrs |
| Operating Temperature | -20°C ~ +55°C | -20°C ~ +55°C |
| Storage Temperature | -30°C ~ +65°C | -30°C ~ +65°C |
| Application | Indoor | Indoor |
| IP Rating | IP44 | IP44 |
| Dimmable | Yes | Yes |
| Cut-out | 4 Inch | 6 Inch |
| Housing Color | White | White |
| Estimated Energy Cost (based on 5 hrs/day) | \$1.642/year | \$2.19/year |
| Years it lasts (based on 5 hrs/day) | 25 | 25 |

Remote Controller Details:

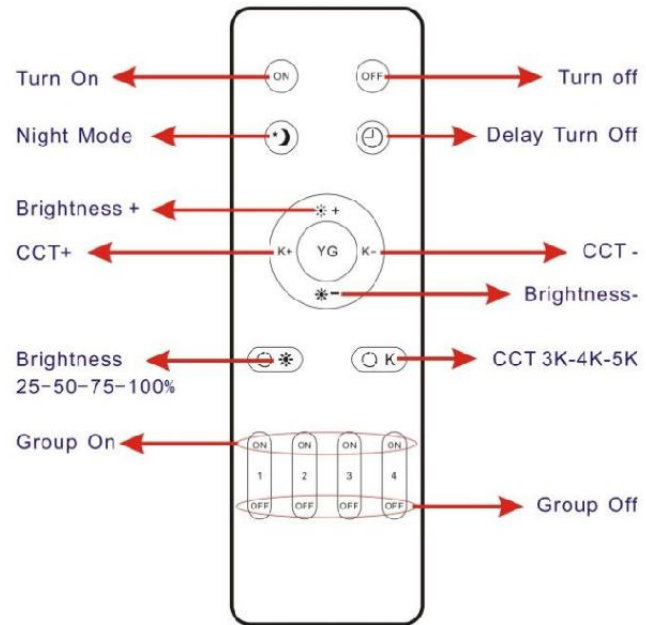

Colour Temperature:

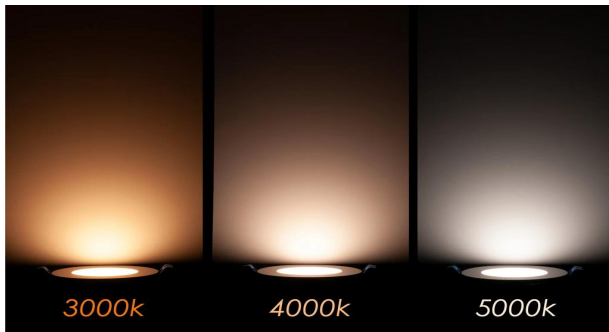

Warm White

Neutral White

Cool White



SMART RINGS

Products:



4" Trim Rings -Black



4" Trim Rings -Brush Nickel



LED Eyeball GIMBAL LIGHTS

Products:



Applications

Ideal for Kitchens, Bathrooms, Hotels, Pools, Restaurants, Showers, Fitness Clubs, Showcases can also be used in a Night Club or on Staircases.

Features

- ETL / cETL / Energy star approved
- 360° Rotation and 90° Tilt
- 120V Triac Dimmable
- Available in Multiple Colors
- IC Rated
- IP54 Wet Location
- 5 Years Warranty
- UL waterproof cable
- Strong spring clips
- Wall switch 3 color changeable is available



| Specs | YG-4G9-3C | YG-4G12-3C |
|---------------------------------------|------------------------|------------|
| Color Temp(CCT) | 3000K/4000K/5000K/3CCT | |
| CRI | >80Ra | >80Ra |
| Input Voltage | 120V | 120V |
| Lumen Output | 900 | 1200 |
| Total Power | 9W | 12W |
| Lumen Efficacy | 100lm/W | 100lm/W |
| Beam Angle | 36° | 36° |
| Life Span | 50,000hrs | 50,000hrs |
| Operating Temperature | -20℃~+40℃ | -20℃~+40℃ |
| Storage Temperature | -40℃~+55℃ | -40℃~+55℃ |
| Application | Indoor | Indoor |
| IP Rating | IP54 | IP54 |
| Dimmable | Yes | Yes |
| Cut-Out | 4inch | 4inch |
| Housing Color | White | White |
| Years it lasts (Based on 5hrs/day) | 25 | 25 |

Diagram:

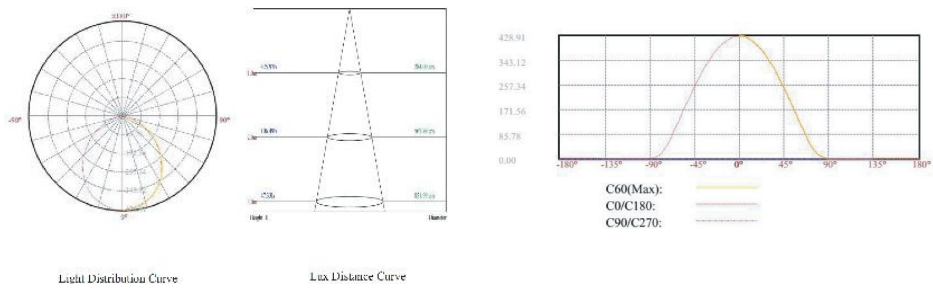
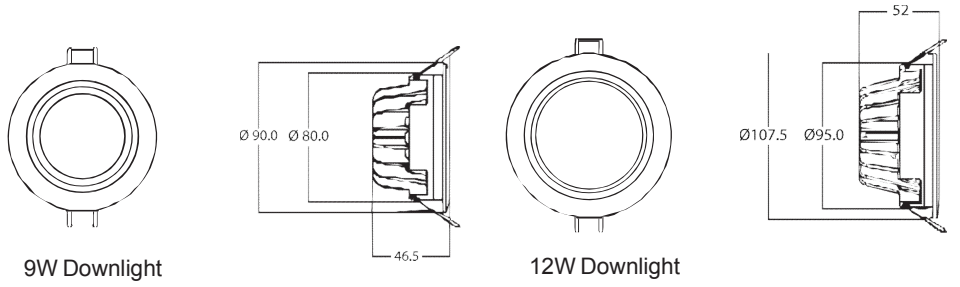

Colour Temperature:

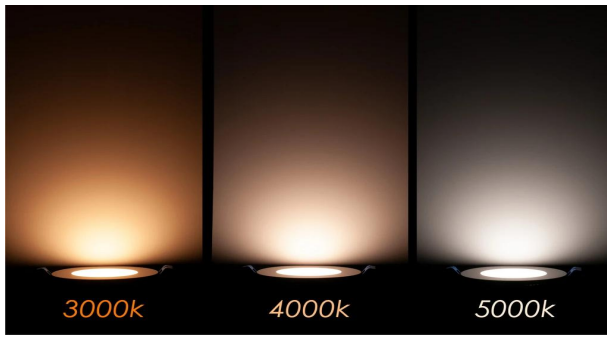

Warm White Neutral White Cool White



LED GIMBAL PANEL LIGHTS

Products:



Applications

Ideal for Kitchens, Bathrooms, Hotels, Pools, Restaurants, Showers, Fitness Clubs, Showcases can also be used in a Night Club or on Staircases.

Features

- ETL / cETL / Energy star approved
- 120V Triac Dimmable
- Available in Multiple Colors
- IC Rated
- Damp Location
- 25 Degree Adjustable
- 5 Years Warranty
- UL waterproof cable
- Strong spring clips
- Square shape is also available
- Wall switch 3 color changeable is available



| Specs | YG-9G-ETL |
|---------------------------------------|------------------------|
| Color Temp(CCT) | 3000K/4000K/5000K/3CCT |
| CRI | >80Ra |
| Input Voltage | 120V |
| Lumen Output | 810 |
| Total Power | 9W |
| Lumen Efficacy | 90lm/W |
| Beam Angle | 180° |
| Life Span | 50,000hrs |
| Operating Temperature | -20°C~+40°C |
| Storage Temperature | -40°C~+55°C |
| Application | Indoor |
| IP Rating | IP44 |
| Dimmable | Yes |
| Cut-Out | 4inch |
| Housing Color | White |
| Years it lasts (Based on 5hrs/day) | 25 |

Drawing:

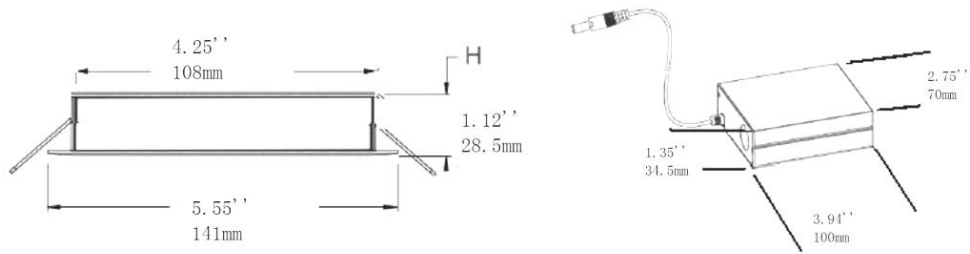

| Type | Value |
|-----------------------|--------------|
| Outer Diameter | 5.55"/141mm |
| Cut Hole | 4.25"/108mm |
| Height (Panel) | 1.12"/28.5mm |
| Height (Junction Box) | 1.35"/34.5mm |
| Length (Junction Box) | 3.94"/100mm |
| Width (Junction Box) | 2.75"/70mm |
| Adjustment Angle | 20° |

Colour Temperature:

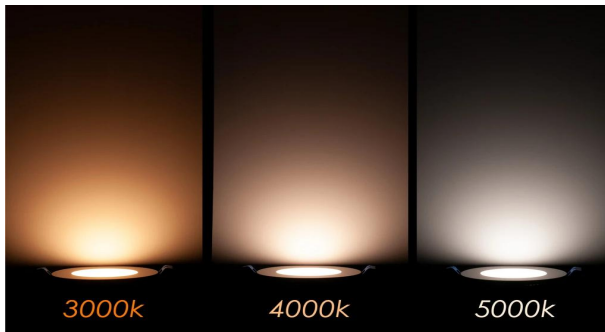

Warm White

Neutral White

Cool White



www.youthgreenled.com



Installation:

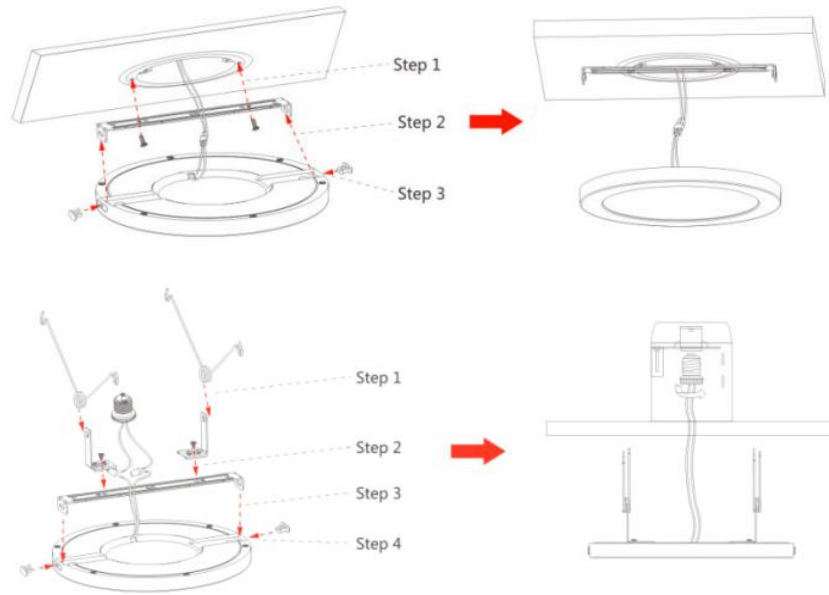

Colour Temperature:

Warm White

Neutral White

Cool White



LED FLUSH MOUNT PANELS

Products:

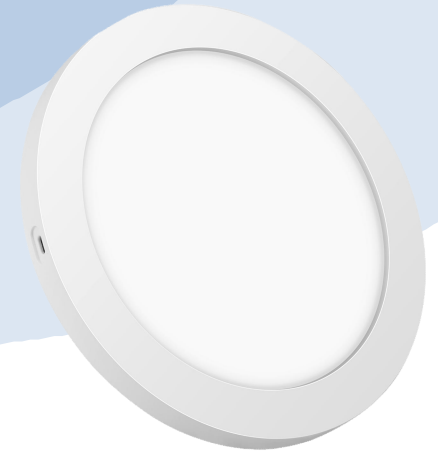

Applications

Ideal for Kitchens, Bathrooms, Hotels, Pools, Restaurants, Showers, Fitness Clubs, Showcases can also be used in a Night Club or on Staircases.

Features

- ETL / cETL approved
- 120V Triac Dimmable
- Available in Multiple Colors
- IC Rated
- Damp Location
- 5 Years Warranty
- 7/9/12in 3 color changeable is available



| Specs | YG-5SM6-ETL | YG-7SM12-ETL | YG-9SM18-ETL | YG-12SM24-ETL |
|------------------------------------|-------------------|--------------|------------------------|---------------|
| Size | 5inch | 7inch | 9inch | 12inch |
| Color Temp(CCT) | 3000K/4000K/5000K | | 3000K/4000K/5000K/3CCT | |
| CRI | >80Ra | | | |
| Input Voltage | 120V | | | |
| Lumen Output | 500 | 950 | 1400 | 1680 |
| Total Power | 6W | 12W | 18W | 24W |
| Lumen Efficacy | 83m/W | | | |
| Beam Angle | 180° | | | |
| Life Span | 50,000hrs | | | |
| Operating Temperature | -20°C~+40°C | | | |
| Storage Temperature | -40°C~+55°C | | | |
| Application | Indoor | | | |
| IP Rating | IP44 | | | |
| Dimmable | Yes | | | |
| Housing Color | White | | | |
| Years it lasts (Based on 5hrs/day) | 25 | | | |

2.4G Remote Control LED FLUSH MOUNT PANELS

Products:

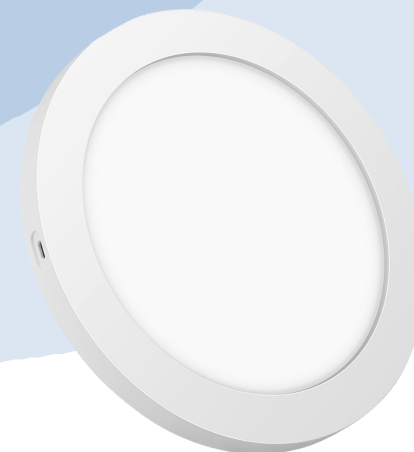

Applications

Ideal for Kitchens, Bathrooms, Hotels, Pools, Restaurants, Showers, Fitness Clubs, Showcases can also be used in a Night Club or on Staircases.

Features

- ETL / cETL / approved
- Wireless Light Temperature Control: 3CCT Adjustable, K+, K-
- Wireless Dimming dimmable, brightness +, brightness -,
- No Dimmer Needed
- Group Control: without limit, 1 apartment 1 remote controller
- Night Mode
- Wireless Power ON/OFF Control
- 5 Years Warranty

www.youthgreenled.com

| Specs | YG-12SM24-ETL |
|---------------------------------------|--|
| Size | 12inch |
| Color Temp(CCT) | 3000K/3500K/4000K/5000K Remote Control |
| CRI | >80Ra |
| Input Voltage | 120V |
| Lumen Output | 3000 |
| Total Power | 24W |
| Lumen Efficacy | 125m/W |
| Beam Angle | 180° |
| Life Span | 50,000hrs |
| Operating Temperature | -20°C~+40°C |
| Storage Temperature | -40°C~+55°C |
| Application | Indoor |
| IP Rating | IP44 |
| Dimmable | Yes |
| Housing Color | White |
| Years it lasts (Based on 5hrs/day) | 25 |

Remote Controller Details:

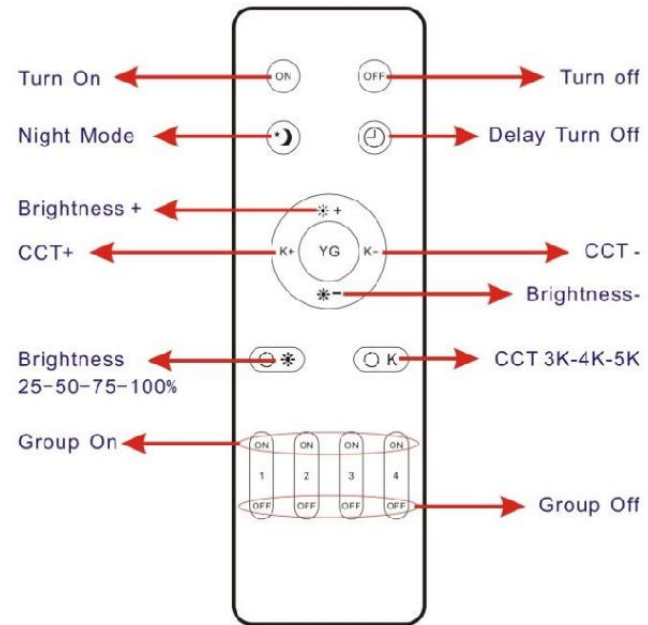

Colour Temperature:

Warm White

Neutral White

Cool White



WIFI LED FLUSH MOUNT PANELS

Products:

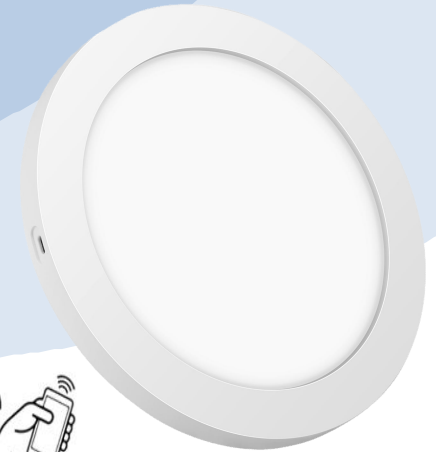

Applications

Ideal for Kitchens, Bathrooms, Hotels, Pools, Restaurants, Showers, Fitness Clubs, Showcases can also be used in a Night Club or on Staircases.

Features

- ETL / cETL approved
- Voice & APP control
- 2000K-6000K White Colors
- Work with Google Assistant /Amazon Alexa
- Schedule or timer, Group multiple lights
- 5 Years Warranty
- No Distance Limited
- NO NEED switch, NO NEED dimmer, use Mobile
- Phone control directly

| Specs | YG-12SM24-ETL |
|---------------------------------------|-------------------------|
| Size | 12inch |
| Color Temp(CCT) | 2000K-6000K APP Control |
| CRI | >80Ra |
| Input Voltage | 120V |
| Lumen Output | 3000 |
| Total Power | 24W |
| Lumen Efficacy | 125m/W |
| Beam Angle | 180° |
| Life Span | 50,000hrs |
| Operating Temperature | -20°C~+40°C |
| Storage Temperature | -40°C~+55°C |
| Application | Indoor |
| IP Rating | IP44 |
| Dimmable | Yes |
| Housing Color | White |
| Years it lasts (Based on 5hrs/day) | 25 |

Installation:



1. After removing the product, unscrew the fix ring from the lamp body (counterclockwise rotation)

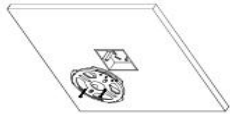

2. Install the fix ring to the ceiling, here supply two kinds of screws:

a. Tapered self-tapping screw
 (For solid ceilings)

b. Flat screw
 (For wire boxes)

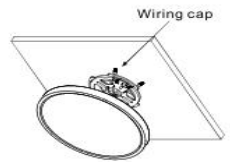

3. Connect the AC wire, L/N.
 (The lamp body is made of insulating plastic, no need connected to the ground wire)

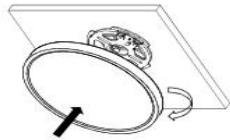

4. Install the lamp body onto the fix ring by rotating it, then finish installation!

Colour Temperature:

Warm White

Neutral White

Cool White



LED Ceiling Light Smart Light





SHENZHEN YOUTH GREEN LIGHTING TECHNOLOGY CO.,LTD

Tel: +86-135 4326 3953

Fax: +86-755 36628289

Web: www.youthgreenled.com

Email: info@youthgreenled.com

Factory Add: Youthgreen Commercial Park,Longhua District,Shenzhen City,China.

